





What's in My Classroom?

Trace the shapes. Write a number in the column.

How many _____ are there?

Name

BOSTER







B3 U1 - My Classroom

How Many are There?

Draw a  on each  book.

Draw a  triangle on each  pencil.

Draw a  square on each  scissor.

There are _ _ .  =   =   = 

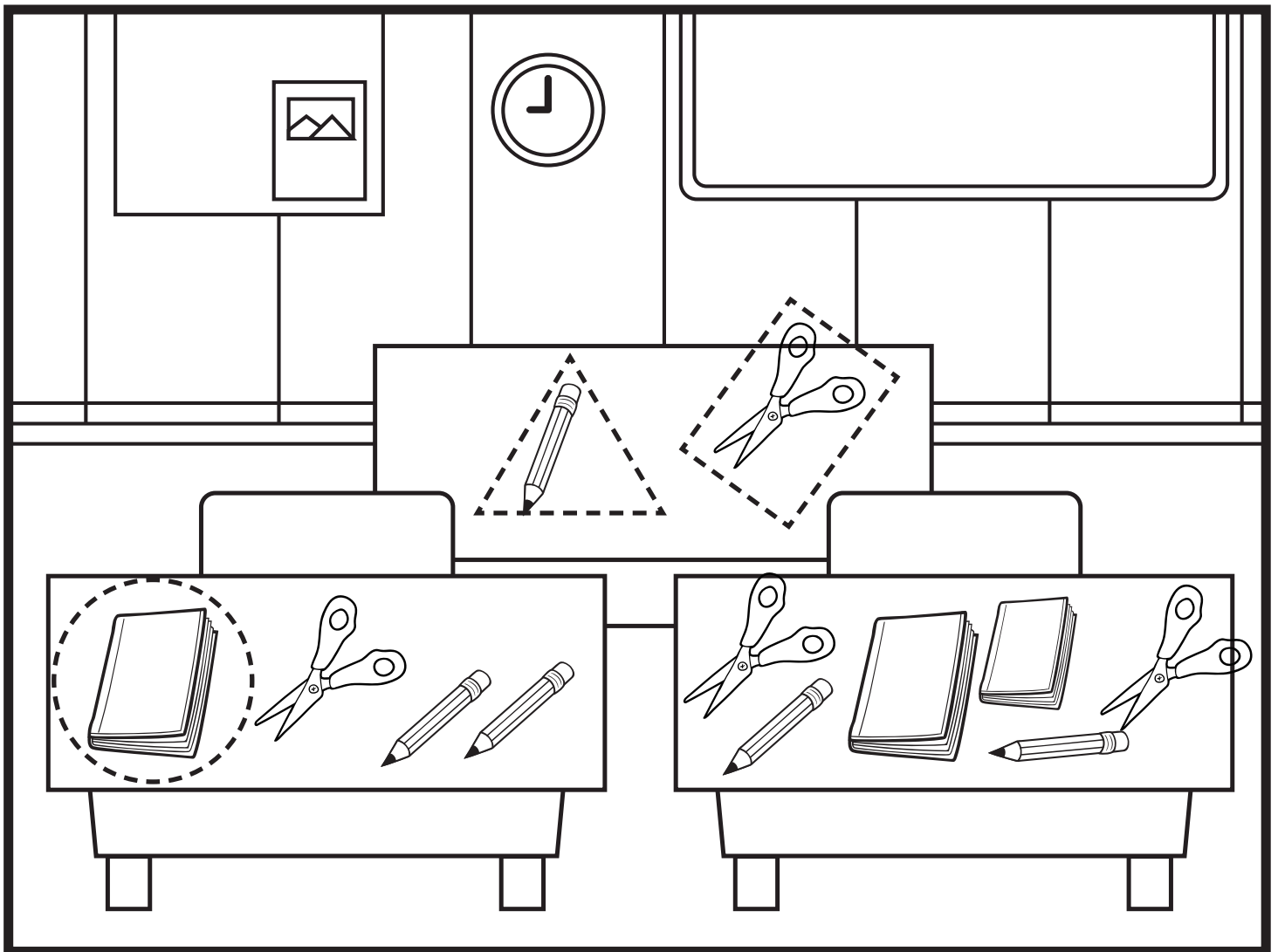

Name

BOSTER

B3 U1 - My Classroom

2

Do and Say

Color the picture and say the sentence.

What do we use to cut? We use scissors to cut.

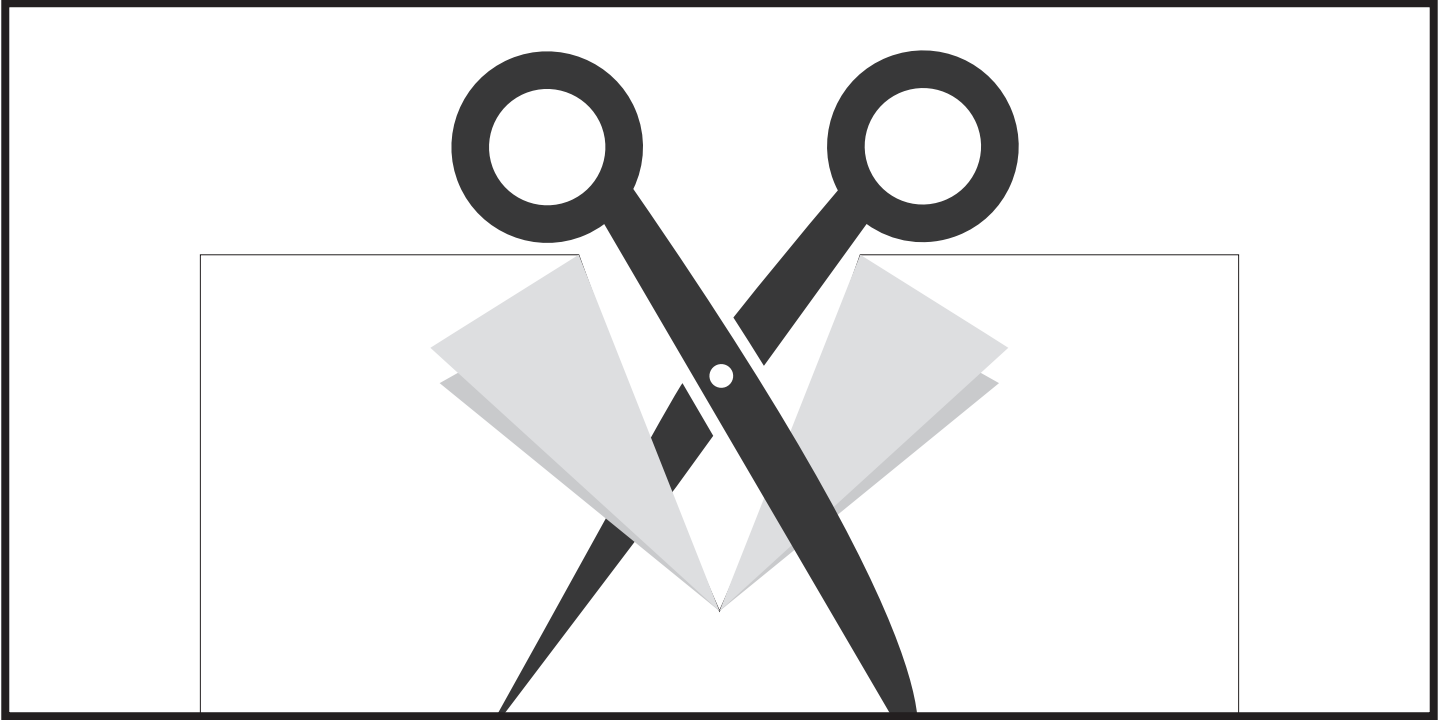

What do we use to color? We use markers to color.

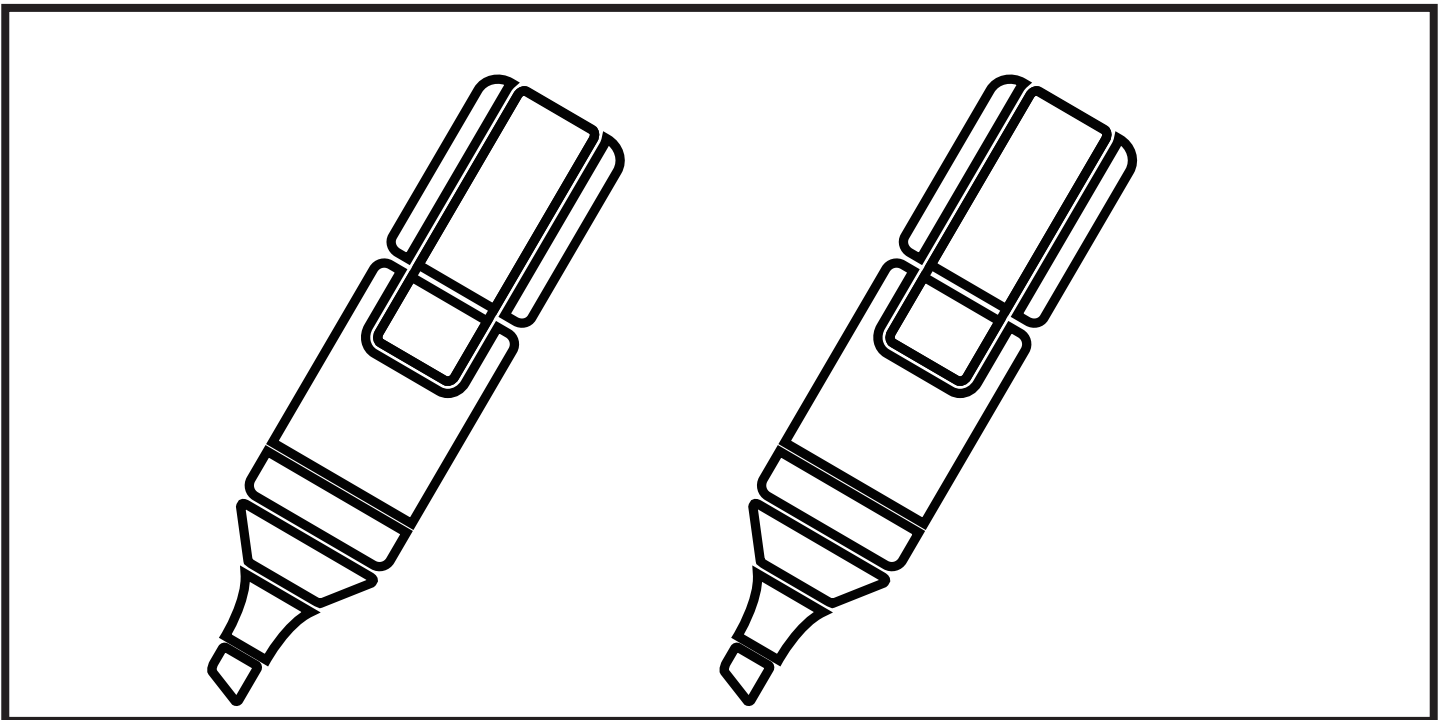

Name

B⁰_STER

B3 U1 - My Classroom

3

Color and Say!

Color the elephant and the bird.

Which is heavier?



The  is heavier.

Which is lighter?



The  is lighter.

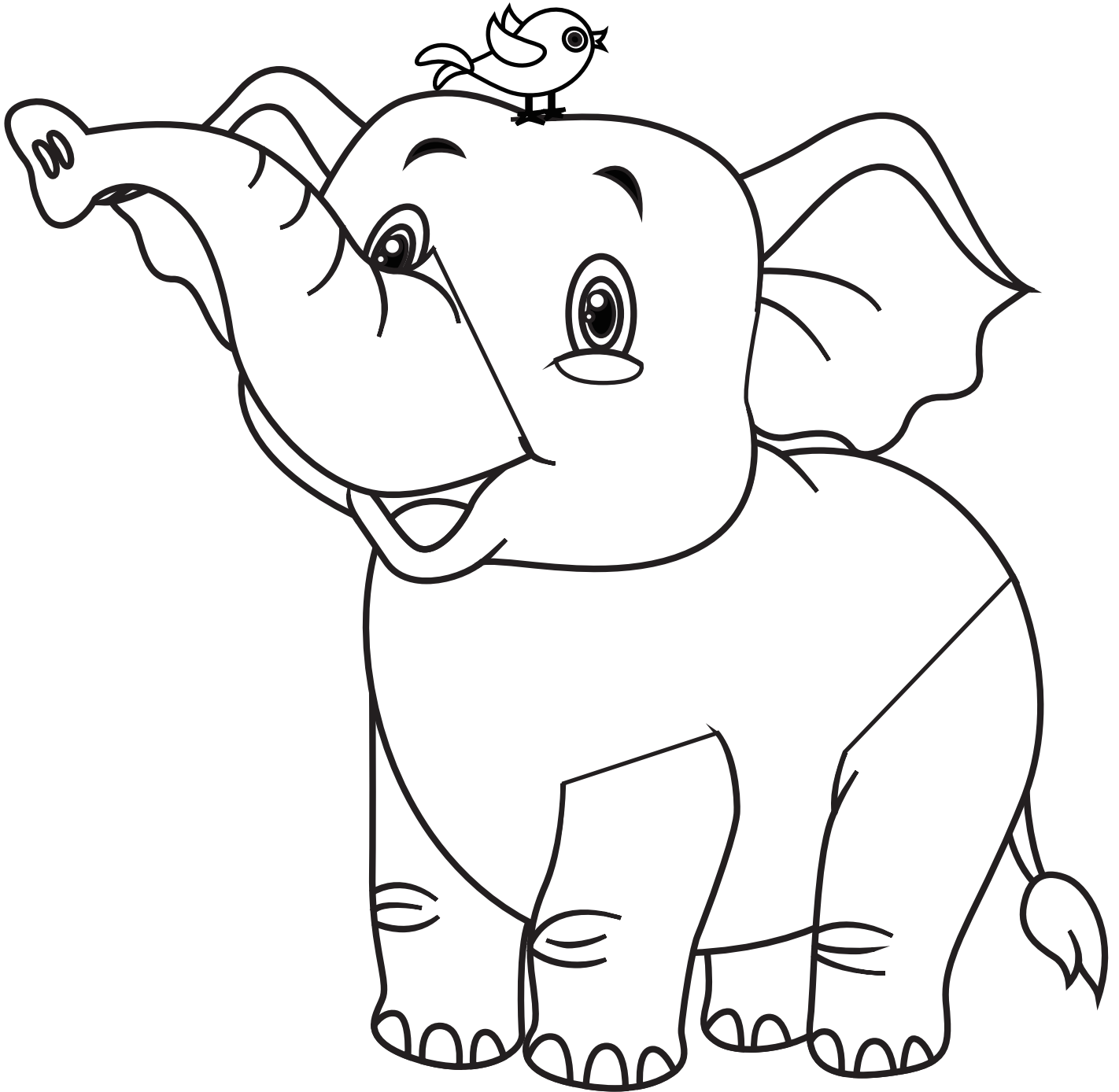

Name

B⁰_STER

B3 U1 - My Classroom

4